

# *NEXT GENERATION*

*Let's join together!*





[ 2 ]

# PROTECTION 1



[ 3 ]



[ 4 ]

# PROTECTION 1



[ 5 ]

Frontdekore | Front finishes | Façades | Front kleuren

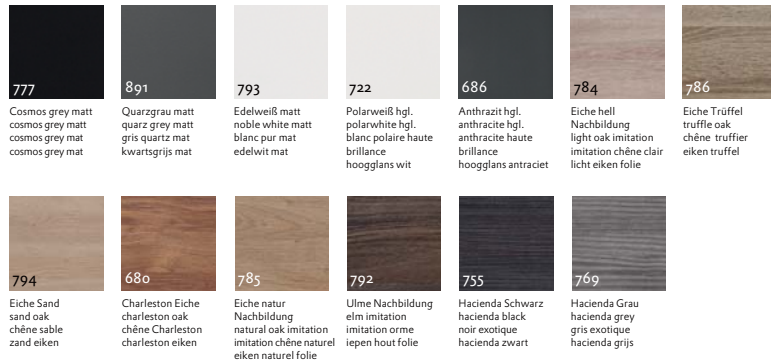

Korpusdekore | Carcase colours | Corps de meuble | Corpus kleuren



[ 6 ]



Nr. 294  
Stangengriff chrom  
handle chrome  
poignée barre chrome  
stangengreep chrom



# PROTECTION 1



Planungsbeispiele  
Planning examples | Exemples de composition | Sets

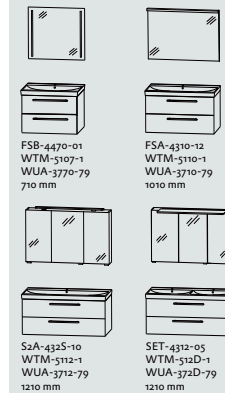

Ergänzungsschränke | Additional cabinets | Meubles complémentaires | Losse kasten

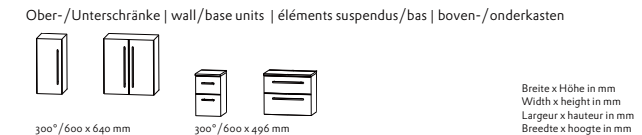
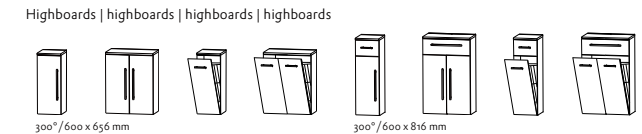
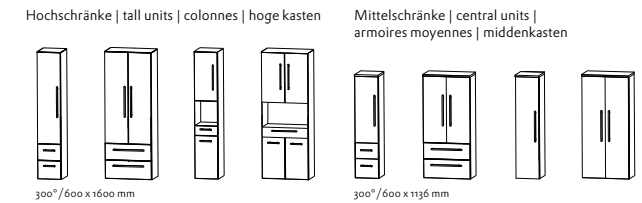

\* Schränke auch in 400 mm Breite erhältlich.  
\* Cabinets also available with a width of 400 mm.  
\* Les armoires sont également disponibles avec une largeur de 400 mm.  
\* Kasten ook verkrijgbaar in 400 mm breedte.

- Auszug aus dem Typenplan
- Die Artikelnummern der Ergänzungsschränke entnehmen Sie aus den Typenlisten.
- Türen - Auszüge - Schubkästen mit Dämpfung
- Extrait du plan type
- Les références des meubles complémentaires sont présentes dans notre liste d'articles.
- Portes - tiroirs - coulissants avec amortisseurs
- Getoonde kasten zijn een selectie uit de kast mogelijkheden
- De bestelcodes van de losse kasten kunt vindt u bij de losse elementen.
- Deuren en lades met softclose

[ 7 ]



[ 8 ]



# D. LIGHT



[ 9 ]





Frontdekore | Front finishes | Façades | Front kleuren

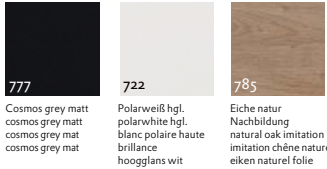

**777**  
Cosmos grey matt  
cosmos grey matt  
cosmos grey mat  
cosmos grey mat

**722**  
Polarweiß hgl.  
polarwhite hgl.  
blanc polaire haute  
brillance  
hoogglans wit

**785**  
Eiche natur  
Nachbildung  
natural oak imitation  
imitation chêne naturel  
eiken naturel folie

Korpusdekore | Carcase colours | Corps de meuble | Corpus kleuren



**177**  
Cosmos grey matt  
cosmos grey matt  
cosmos grey mat  
cosmos grey mat

**161**  
Weiß hgl.  
white hgl.  
blanc haute brillance  
hoogglans wit

**185**  
Eiche natur  
Nachbildung  
natural oak imitation  
imitation chêne naturel  
eiken naturel folie



Nr. 334  
Griffleiste chrom  
strip handle chrome  
profilé poignée chrome  
grieplijst chrom



Nr. 343  
Griffleiste alu matt  
strip handle alu matt  
profilé poignée alu mat  
grieplijst alu mat



Nr. 344  
Griffleiste schwarz matt  
strip handle black matt  
profilé poignée noir mat  
grieplijst zwart mat

# D. LIGHT



Planungsbeispiele  
Planning examples | Exemples de composition | Sets

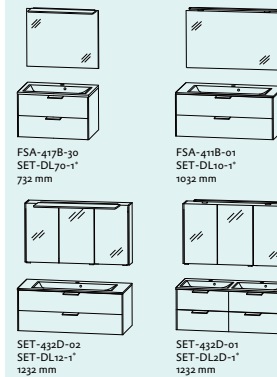

FSA-417B-30  
SET-DL70-1\*  
732 mm

FSA-411B-01  
SET-DL10-1\*  
1032 mm

SET-432D-02  
SET-DL12-1\*  
1232 mm

SET-432D-01  
SET-DL2D-1\*  
1232 mm

\* auch mit LED-Beleuchtung erhältlich  
\* also available with LED lighting  
\* aussi disponible avec éclairage LED  
\* ook mogelijk met LED verlichting

Ergänzungsschränke | Additional cabinets | Meubles complémentaires | Losse kasten

Mittelschränke | central units | armoires moyennes | middenkasten

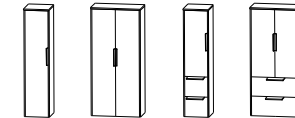

322 / 622 x 1290 mm

Highboards | highboards | highboards | highboards

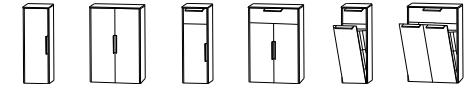

322 / 622 x 810 mm

Ober-/Unterschränke | wall/base units | éléments suspendus/bas | boven-/onderkasten

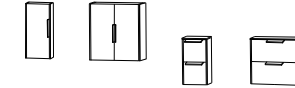

320 / 620 x 640 mm

322 / 622 x 490 mm

Breite x Höhe in mm  
Width x height in mm  
Largeur x hauteur in mm  
Breedte x hoogte in mm

- Auszug aus dem Typenplan  
- Die Artikelnummern der Ergänzungsschränke entnehmen Sie aus den Typenlisten.  
- Türen · Auszüge · Schubkästen mit Dämpfung

- Extrait du plan type  
- Les références des meubles complémentaires sont présentes dans notre liste d'articles.  
- Portes · tiroirs · coulissants avec amortisseurs

- Part of the type list  
- Please consult the type lists for the article numbers of the add-on cabinets.  
- Doors · pull out units · drawers with buffered closing

- Getoonde kasten zijn een selectie uit de kast mogelijkheden  
- De bestelcodes van de losse kasten kunt vindt u bij de losse elementen.  
- Deuren en lades met softclose



[ 12 ]



*UNI* **UNIQUE**

[ 13 ]



**Planungsbeispiele**  
Planning examples | Exemples de composition | Sets

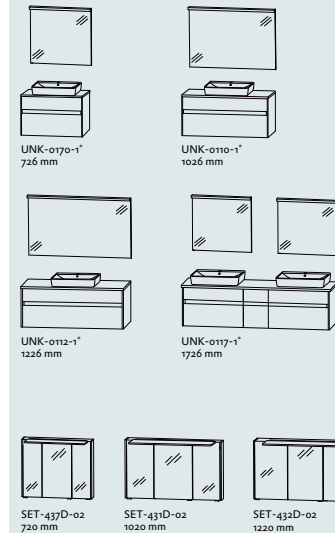

\* auch mit LED-Beleuchtung erhältlich  
\* also available with LED lighting  
\* aussi disponible avec éclairage LED  
\* ook mogelijk met LED verlichting

Abbildungen mit „Ideal Standard CONNECT AIR“ Waschtisch.  
Technical drawing with „Ideal Standard CONNECT AIR“ washbasin.  
Les exemples de composition avec vasque à poser „Ideal Standard CONNECT AIR“.  
Afgebeeld is met „Ideal Standard CONNECT AIR“ wastafel.

# UNI UNIQUE

**Ergänzungsschränke** | Additional cabinets | Meubles complémentaires | Losse kasten



**Highboards** | highboards | highboards | highboards

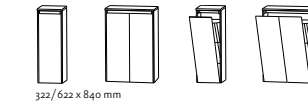

**Ober-/Unterschränke** | wall/base units | éléments suspendus/bas | boven-/onderkasten

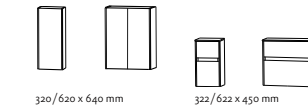

Breite x Höhe in mm  
Width x height in mm  
Largeur x hauteur in mm  
Breedte x hoogte in mm

Abbildungen grifflos, auch mit Griffleiste möglich.  
Technical drawings handleless, also available with strip-handle.  
Les exemples de composition sans poignée possible avec poignée.  
Abeelden zijn greeploos, met greeplijst zijn ook mogelijk.

- Auszug aus dem Typenplan
- Die Artikelnummern der Ergänzungsschränke entnehmen Sie aus den Typenlisten.
- Türen - Auszüge - Schubkästen mit Dämpfung
- Extrait du plan type
- Les références des meubles complémentaires sont présentes dans notre liste d'articles.
- Portes - tiroirs - coulissants avec amortisseurs
- Getoonde kasten zijn een selectie uit de kast mogelijkheden
- De bestelcodes van de losse kasten kunt vindt u bij de losse elementen.
- Deuren en lades met softclosing

**Frontdekore** | Front finishes | Façades | Front kleuren



**Waschtischplatten- und Abdeckplattendekore** | Washbasin top and top cover colours | Coloris plan de toilette pour vasque à poser et coloris de plateaux de recouvrement | Wastafelplaat en afdeklad kleuren



**Korpusdekore** | Carcase colours | Corps de meuble | Corpus kleuren



grifflos - Griffprofil in Korpusdekor  
handleless - handle profile in carcase colour  
sans poignée - profil de poignée en coloris de corps  
greeploos - greepprofiel in corpus kleur

Nr. 324  
Griffleiste chrom  
strip handle chrome  
profilé poignée chrome  
greeplijst chrom



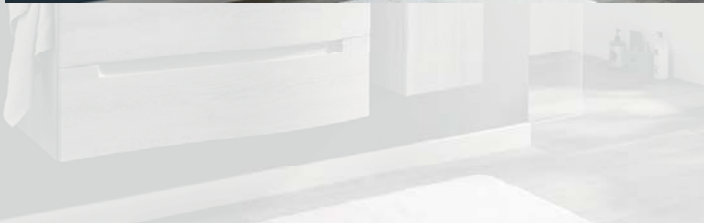

[ 16 ]

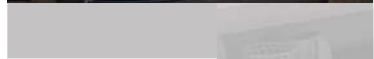
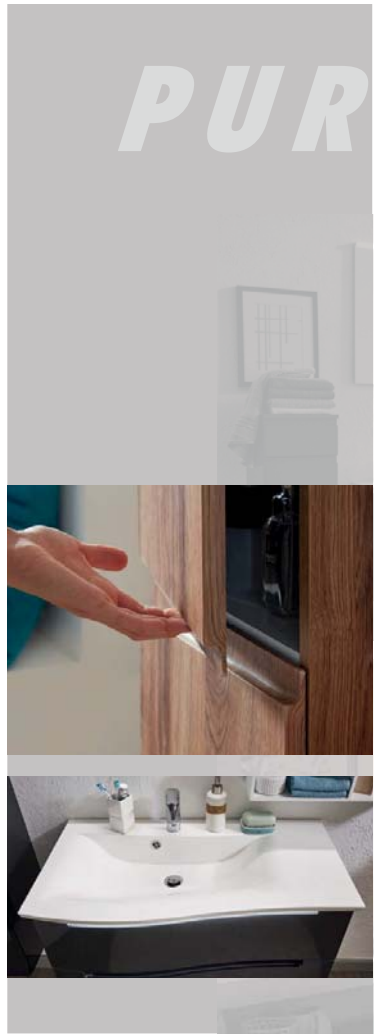

# PUREFACTION



[ 17 ]



### Frontdekore | Front finishes | Façades | Front kleuren



### Korpusdekore | Carcase colours | Corps de meuble | Corpus kleuren



grifflos  
mit Griffmulde  
hand/less  
with recessed grip  
sans poignée avec  
prise de main en creux  
greeploos  
met inbouwgreep



# PUREFACTION



### Planungsbeispiele Planning examples | Exemples de composition | Sets

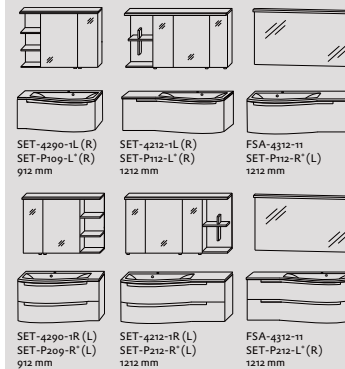

\* auch mit LED-Beleuchtung erhältlich  
\* also available with LED lighting  
\* aussi disponible avec éclairage LED  
\* ook mogelijk met LED verlichting

### Ergänzungsschränke | Additional cabinets | Meubles complémentaires | Losse kasten

Hohschränke | tall units | colonnes | hoge kasten

Mittelschränke | central units |  
armoires moyennes | middenkasten

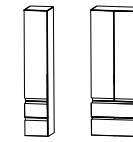

300°/600 x 1600 mm

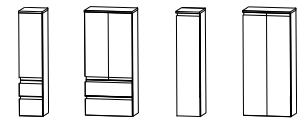

300°/600 x 1136 mm

Highboards | highboards | highboards | highboards

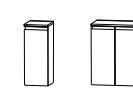

300°/600 x 656 mm

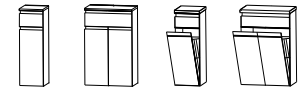
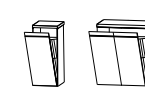

300°/600 x 816 mm

Ober-/Unterschränke | wall/base units | éléments suspendus/bas | boven-/onderkasten

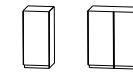

300°/600 x 640 mm

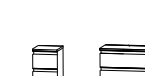

300°/600 x 496 mm

Breite x Höhe in mm  
Width x height in mm  
Largeur x hauteur in mm  
Breedte x hoogte in mm

\* Schränke auch in 400 mm Breite erhältlich.  
\* Cabinets also available with a width of 400 mm.  
\* Les armoires sont également disponibles avec une largeur de 400 mm.  
\* Kasten ook verkrijgbaar in 400 mm breedte.

- Auszug aus dem Typenplan  
- Die Artikelnummern der Ergänzungsschränke entnehmen Sie aus den Typenlisten.  
- Türen - Auszüge - Schubkästen mit Dämpfung

- Extrait du plan type  
- Les références des meubles complémentaires sont présentes dans notre liste d'articles.  
- Portes - tiroirs - coulissants avec amortisseur

- Part of the type list  
- Please consult the type lists for the article numbers of the add-on cabinets.  
- Doors - pull out units - drawers with buffered closing

- Getoonde kasten zijn een selectie uit de kast mogelijkheden  
- De bestelcodes van de losse kasten kunt vindt u bij de losse elementen.  
- Deuren en lades met softclosing

**QUADA**



[ 20 ]



[ 21 ]

Frontdekore | Front finishes | Façades | Front kleuren

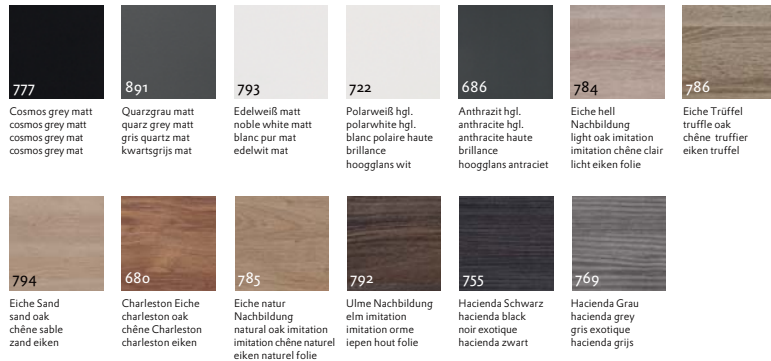

Korpusdekore | Carcase colours | Corps de meuble | Corpus kleuren



Nr. 321  
Stangengriff chrom  
handle chrome  
poignée barre chrome  
stangengreep chrom

Planungsbeispiele  
Planning examples | Exemples de composition | Sets

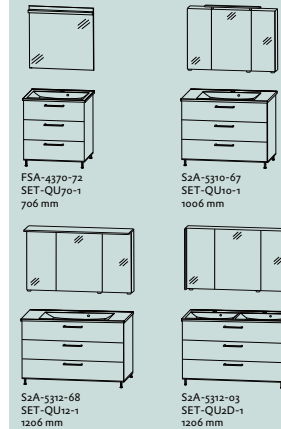

Abbildungen mit Mineralguss-Waschtisch, auch in Keramik erhältlich.  
Technical drawing with cast mineral washbasin, also available in ceramic.  
Les exemples de compositions avec plan vasque en matériau de synthèse  
sont également disponible en céramique.  
Afbeeldingen zijn met minerale wastafels, keramische wastafels zijn ook  
mogelijk.

# QUADA

Ergänzungsschränke | Additional cabinets | Meubles complémentaires | Losse kasten

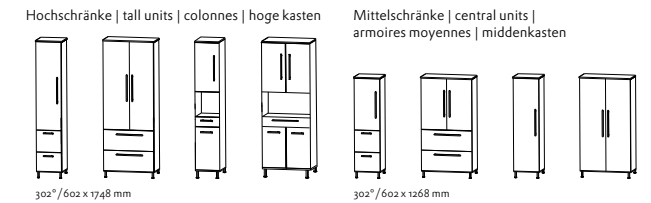

Highboards | highboards | highboards | highboards

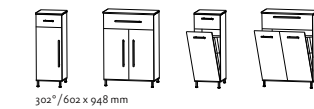

Oberschränke | wall units | éléments suspendus | bovenkasten



\* Schränke auch in 402 mm (Oberschränke 400 mm) Breite erhältlich.  
\* Cabinets also available with a width of 402 mm (wall units 400 mm).  
\* Les armoires sont également disponibles avec une largeur de 402 mm (éléments suspendus 400 mm).  
\* Kasten ook verkrijgbaar in 402 mm (bovenkasten 400 mm) breedte.

– Auszug aus dem Typenplan  
– Die Artikelnummern der Ergänzungsschränke entnehmen Sie aus den Typenlisten.  
– Türen · Auszüge · Schubkästen mit Dämpfung  
– Deurs · pull out units · drawers with buffered closing

– Extrait du plan type  
– Les références des meubles complémentaires sont présentes dans notre liste d'articles.  
– Portes · tiroirs · coulissants avec amortisseur

– Getoonde kasten zijn een selectie uit de kast mogelijkheden  
– De bestelcodes van de losse kasten kunt vindt u bij de losse elementen.  
– Deuren en lades met softclose

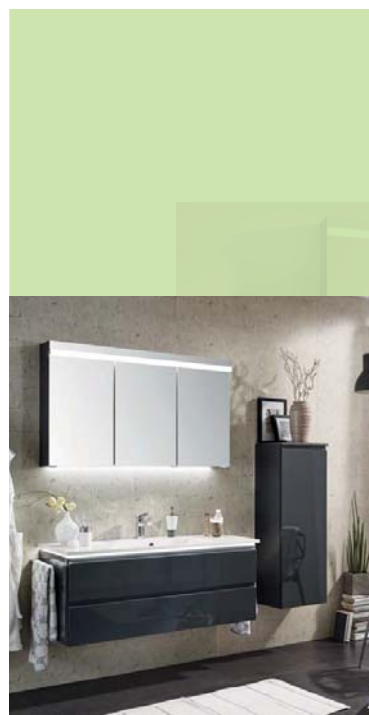

**A ACE**





**Frontdekore | Front finishes | Façades | Front kleuren**

<b>672</b> Polarweiß hgl. polarwhite hgl. blanc polaire haute brillance hoogglans wit	<b>671</b> Anthraxit hgl. anthracite hgl. anthracite haute brillance hoogglans antraciet	<b>675</b> Eiche Sand sand oak chêne sable zand eiken	<b>673</b> Eiche Trüffel truffe oak chêne truffier eiken truffel	<b>676</b> Charleston Eiche charleston oak chêne Charleston charleston eiken	<b>674</b> Ulme Nachbildung elm imitation imitation orme iepen hout folie
--	---	---	--	--	---

**Korpusdekore | Carcase colours | Corps de meuble | Corpus kleuren**

<b>190</b> Perlstruktur Weiß matt pearl texture white matt blanc structure perlée mat parelstructuur wit mat	<b>161</b> Weiß hgl. white hgl. blanc haute brillance hoogglans wit	<b>121</b> Anthraxit hgl. anthracite hgl. anthracite haute brillance hoogglans antraciet	<b>194</b> Eiche Sand sand oak chêne sable zand eiken	<b>186</b> Eiche Trüffel truffe oak chêne truffier eiken truffel	<b>180</b> Charleston Eiche charleston oak chêne Charleston charleston eiken	<b>192</b> Ulme Nachbildung elm imitation imitation orme iepen hout folie
---	--	---	---	--	--	---



grifflos mit Griffmulde  
handleless with recessed grip  
sans poignée avec prise de main en creux  
grieploos met inbouwgreep



**Planungsbeispiele**  
Planning examples | Exemples de composition | Sets

 <b>FSA-4370-72</b> SET-7012-1* 720 mm	 <b>S2A-437S-72</b> SET-7012-1* 720 mm
 <b>FSA-4310-72</b> SET-1012-1* 1020 mm	 <b>S2A-431S-72</b> SET-1012-1* 1020 mm
 <b>FSA-4312-72</b> SET-1212-1* 1220 mm	 <b>S2A-432S-72</b> SET-122D-1* 1220 mm

\* auch mit LED-Beleuchtung erhältlich \* also available with LED lighting  
\* aussi disponible avec éclairage LED \* ook mogelijk met LED verlichting  
Abbildungen mit Mineralguss-Waschtisch, auch in Glas oder Keramik erhältlich.  
Technical drawing with cast mineral washbasin, also available in glass or ceramic.  
Les exemples de composition avec plan vasque en matériau de synthèse sont également disponible en verre ou en céramique.  
Afbeeldingen zijn met minerale wastafels, glazen en keramische wastafels zijn ook mogelijk.



**Ergänzungsschränke | Additional cabinets | Meubles complémentaires | Losse kasten**

<b>Hochschränke   tall units   colonnes   hoge kasten</b>  300°/600 x 1600 mm	<b>Mittelschränke   central units   armoires moyennes   middenkasten</b>  300°/600 x 1136 mm
<b>Highboards   highboards   highboards   highboards</b>  300°/600 x 656 mm	 300°/600 x 816 mm
<b>Ober-/Unterschränke   wall/base units   éléments suspendus/bas   boven-/onderkasten</b>  300°/600 x 640 mm	 300°/600 x 496 mm

Breite x Höhe in mm  
Width x height in mm  
Largeur x hauteur in mm  
Breedte x hoogte in mm

\* Schränke auch in 400 mm Breite erhältlich.  
\* Cabinets also available with a width of 400 mm.  
\* Les armoires sont également disponibles avec une largeur de 400 mm.  
\* Kasten ook verkrijgbaar in 400 mm breedte.

- |  |   |
|--|---|
| <ul style="list-style-type: none"> <li>- Auszug aus dem Typenplan</li> <li>- Die Artikelnummern der Ergänzungsschränke entnehmen Sie aus den Typenlisten.</li> <li>- Türen - Auszüge - Schubkästen mit Dämpfung</li> </ul>           | <ul style="list-style-type: none"> <li>- Extrait du plan type</li> <li>- Les références des meubles complémentaires sont présentes dans notre liste d'articles.</li> <li>- Portes - tiroirs - coulissants avec amortisseur</li> </ul>       |
| <ul style="list-style-type: none"> <li>- Part of the type list</li> <li>- Please consult the type lists for the article numbers of the add-on cabinets.</li> <li>- Doors - pull out units - drawers with buffered closing</li> </ul> | <ul style="list-style-type: none"> <li>- Getoonde kasten zijn een selectie uit de kast mogelijkheden</li> <li>- De bestelcodes van de losse kasten kunt vindt u bij de losse elementen.</li> <li>- Deuren en lades met softclose</li> </ul> |

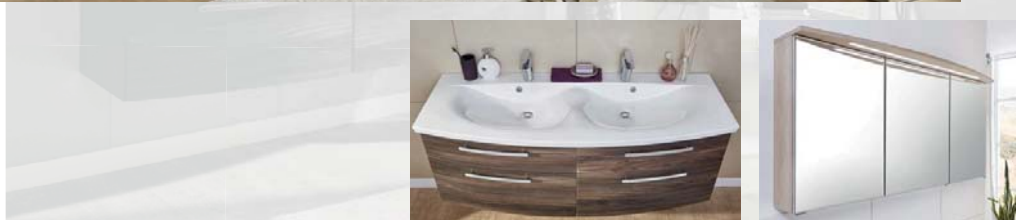

[ 28 ]

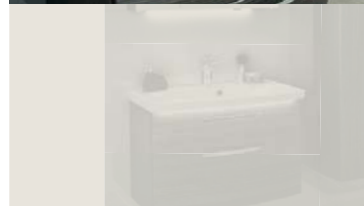

# VUEVUELTA



[ 29 ]

Frontdekore | Front finishes | Façades | Front kleuren



Korpusdekore | Carcase colours | Corps de meuble | Corpus kleuren

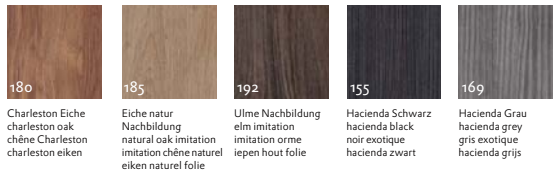
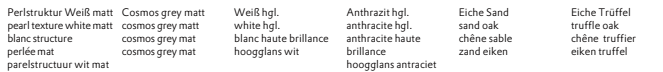
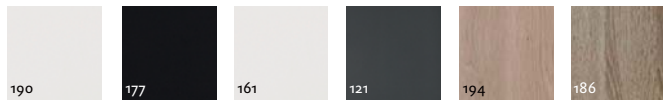

Charleston Eiche  
charleston oak  
chêne charleston  
charleston eiken

Eiche natur  
Nachbildung  
natural oak imitation  
imitation chêne naturel  
eiken naturel folie

Ulme Nachbildung  
elm imitation  
imitation orme  
iepen hout folie

Hacienda Schwarz  
hacienda black  
noir exotique  
hacienda zwart

Hacienda Grau  
hacienda grey  
gris exotique  
hacienda grijs



Planungsbeispiele  
Planning examples | Exemples de composition | Sets



\* auch mit Facettenschliff erhältlich  
\*\* also available with facet cut

\*\* auch mit LED-Beleuchtung erhältlich  
\*\* also available with LED lighting

\* ook mogelijk met facet rand  
\*\* ook mogelijk met LED verlichting

# VUEVELTA

Ergänzungsschränke | Additional cabinets | Meubles complémentaires | Losse kasten

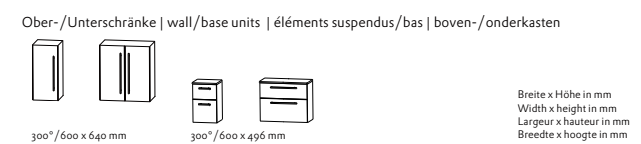
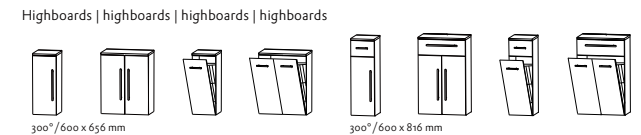
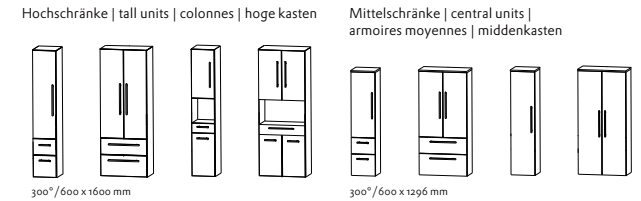

\* Schränke auch in 400 mm Breite erhältlich.  
\* Cabinets also available with a width of 400 mm.  
\* Les armoires sont également disponibles avec une largeur de 400 mm.  
\* Kasten ook verkrijgbaar in 400 mm breedte.

- Auszug aus dem Typenplan  
- Die Artikelnummern der Ergänzungsschränke entnehmen Sie aus den Typenlisten.  
- Türen - Auszüge - Schubkästen mit Dämpfung

- Extrait du plan type  
- Les références des meubles complémentaires sont présentes dans notre liste d'articles.  
- Portes - tiroirs - coulissants avec amortisseur

- Part of the type list  
- Please consult the type lists for the article numbers of the add-on cabinets.  
- Doors - pull out units - drawers with buffered closing

- Getoonde kasten zijn een selectie uit de kast mogelijkheden  
- De bestelcodes van de losse kasten kunt vindt u bij de losse elementen.  
- Deuren en lades met softclose





[ 32 ]

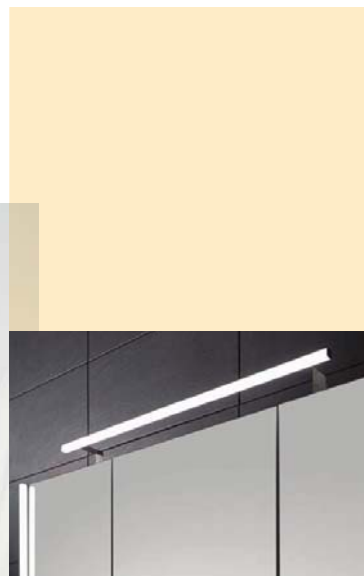

**L I N E A**



[ 33 ]

Frontdekore | Front finishes | Façades | Front kleuren



**777**  
Cosmos grey matt  
cosmos grey matt  
cosmos grey mat  
cosmos grey mat

**793**  
Edelweiß matt  
noble white matt  
blanc pur mat  
edelwit mat

**722**  
Polarweiß hgl.  
polarwhite hgl.  
blanc polaire haute  
brillance  
hoogglans wit

**686**  
Anthrazit hgl.  
anthracite hgl.  
anthracite haute  
brillance  
hoogglans antraciet



**784**  
Eiche hell  
Nachbildung  
light oak imitation  
imitation chêne clair  
licht eiken folie

**786**  
Eiche Trüffel  
truffel oak  
chêne truffier  
eiken truffel

**680**  
Charleston Eiche  
charleston oak  
chêne Charleston  
charleston eiken

**785**  
Eiche natur  
Nachbildung  
natural oak imitation  
imitation chêne naturel  
eiken naturel folie

**792**  
Ulme Nachbildung  
elm imitation  
imitation orme  
iepen hout folie

**755**  
Hacienda Schwarz  
hacienda black  
noir exotique  
hacienda zwart

**769**  
Hacienda Grau  
hacienda grey  
gris exotique  
hacienda grijs

Korpusdekore | Carcase colours | Corps de meuble | Corpus kleuren



**190**  
Perlstruktur Weiß matt  
pearl texture white matt  
blanc structure  
perlée mat  
parelstructuur wit mat

**177**  
Cosmos grey matt  
cosmos grey matt  
cosmos grey mat

**161**  
Weiß hgl.  
white hgl.  
blanc haute brillante  
hoogglans wit

**121**  
Anthrazit hgl.  
anthracite hgl.  
anthracite haute  
brillance  
hoogglans antraciet

**184**  
Eiche hell  
Nachbildung  
light oak imitation  
imitation chêne clair  
licht eiken folie

**186**  
Eiche Trüffel  
truffel oak  
chêne truffier  
eiken truffel



**180**  
Charleston Eiche  
charleston oak  
chêne Charleston  
charleston eiken

**185**  
Eiche natur  
Nachbildung  
natural oak imitation  
imitation chêne naturel  
eiken naturel folie

**192**  
Ulme Nachbildung  
elm imitation  
imitation orme  
iepen hout folie

**155**  
Hacienda Schwarz  
hacienda black  
noir exotique  
hacienda zwart

**169**  
Hacienda Grau  
hacienda grey  
gris exotique  
hacienda grijs



Nr. 317  
Stangengriff chrom  
handle chrome  
poignée barre chrome  
stangengreep chroom



Nr. 320  
Stangengriff chrom  
handle chrome  
poignée barre chrome  
stangengreep chroom



Planungsbeispiele  
Planning examples | Exemples de composition | Sets

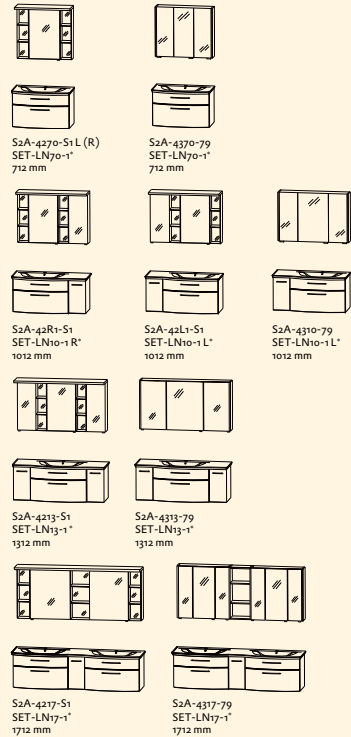

\* auch mit LED-Beleuchtung erhältlich  
\* also available with LED lighting  
\* aussi disponible avec éclairage LED  
\* ook mogelijk met LED verlichting

# LINEA

Ergänzungsschränke | Additional cabinets | Meubles complémentaires | Losse kasten

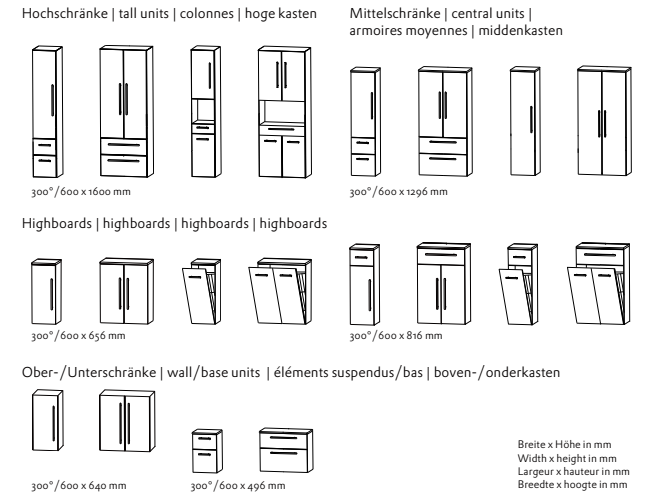

\* Schränke auch in 400 mm Breite erhältlich.  
\* Cabinets also available with a width of 400 mm.  
\* Les armoires sont également disponibles avec une largeur de 400 mm.  
\* Kasten ook verkrijgbaar in 400 mm breedte.

- Auszug aus dem Typenplan
- Die Artikelnummern der Ergänzungsschränke entnehmen Sie aus den Typenlisten.
- Türen - Auszüge - Schubkästen mit Dämpfung
- Extrait du plan type
- Les références des meubles complémentaires sont présentes dans notre liste d'articles.
- Portes - tiroirs - coulissants avec amortisseurs
- Getoonde kasten zijn een selectie uit de kast mogelijkheden
- De bestelcodes van de losse kasten kunt vindt u bij de losse elementen.
- Deuren en lades met softclose



[ 36 ]

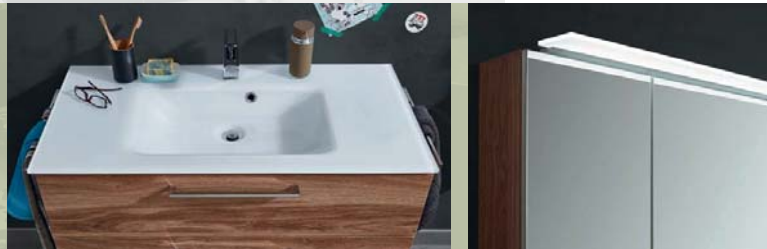

**FRESH**



[ 37 ]





[ 38 ]



# FRESH



[ 39 ]

Frontdekore | Front finishes | Façades | Front kleuren

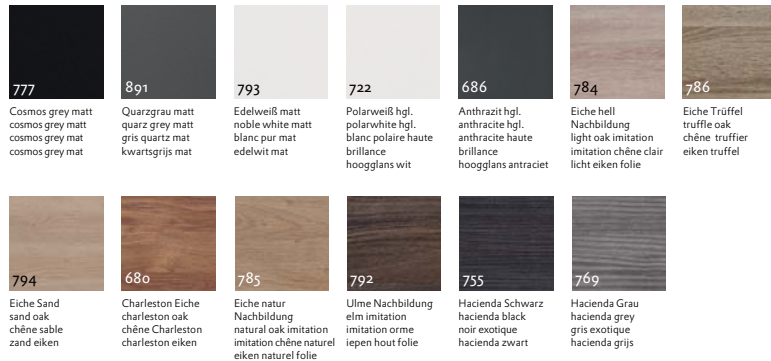

Korpusdekore | Carcase colours | Corps de meuble | Corpus kleuren



Nr. 321  
Stangengriff chrom  
handle chrome  
poignée barre chrome  
stangengreep chroom



Planungsbeispiele  
Planning examples | Exemples de composition | Sets

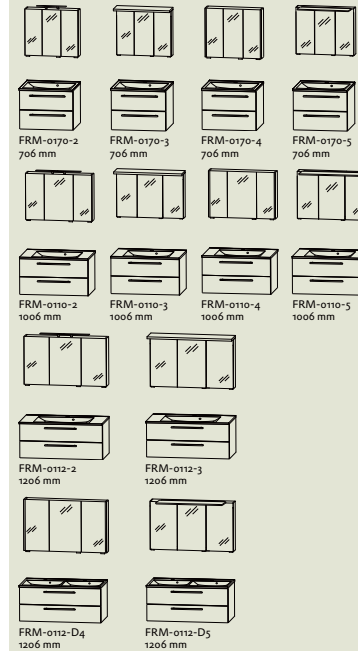

Abbildungen mit Mineralguss-Waschtisch, auch in Glas oder Keramik erhältlich.  
Technical drawing with cast mineral washbasin, also available in glass or ceramic.  
Les exemples de composition avec plan vasque en matériau de synthèse sont également disponible en verre ou en céramique.  
Afbeeldingen zijn met minerale wastafels, glazen en keramische wastafels zijn ook mogelijk.

Alternativ Flächenspiegel in 700 / 1000 / 1200 mm Breite erhältlich.  
Alternative mirrors available in widths 700 / 1000 / 1200 mm.  
Alternativement, miroir disponible en 700 / 1000 / 1200 mm de largeur.  
Alternatief zijn spiegels in 700 / 1000 / 1200 breedte verkrijgbaar.

# FRESH

Ergänzungsschränke | Additional cabinets | Meubles complémentaires | Losse kasten

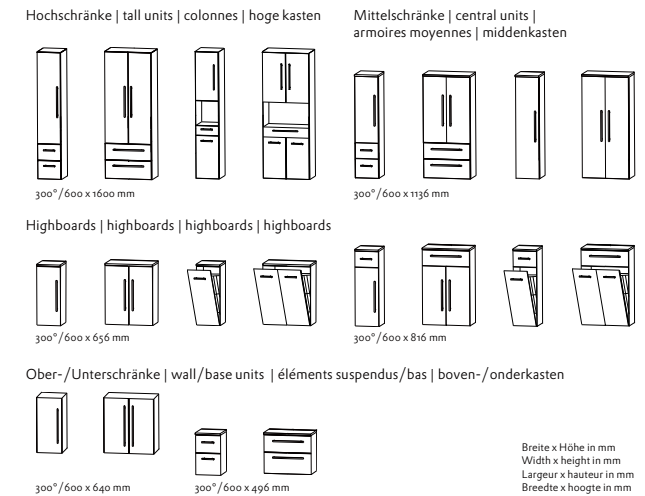

\* Schränke auch in 400 mm Breite erhältlich.  
\* Cabinets also available with a width of 400 mm.  
\* Les armoires sont également disponibles avec une largeur de 400 mm.  
\* Kasten ook verkrijgbaar in 400 mm breedte.

- Auszug aus dem Typenplan
- Die Artikelnummern der Ergänzungsschränke entnehmen Sie aus den Typenlisten.
- Türen - Auszüge - Schubkästen mit Dämpfung
- Extrait du plan type
- Les références des meubles complémentaires sont présentes dans notre liste d'articles.
- Portes - tiroirs - coulissants avec amortisseur
- Getoonde kasten zijn een selectie uit de kast mogelijkheden
- De bestelcodes van de losse kasten kunt vindt u bij de losse elementen.
- Deuren en lades met softclose

Waschtische  
Waschbasins | Plans Vasque | Wastafels



**PROTECTION1** Keramik-Waschtisch, weiß  
ceramic washbasin, white  
plan vasque céramique, blanc  
keramische wastafel, wit



**D.LIGHT** Mineralguss-Waschtisch, weiß  
cast mineral washbasin, white  
plan vasque en matériau de synthèse, blanc  
minerale wastafel, wit



**UNIQUE** „Ideal Standard CONNECT AIR“  
Keramik-Aufsatzwaschtisch, weiß  
ceramic top-mounted washbasin, white | vasque à poser  
céramique, blanc | keramische opzetwastafel, wit



**UNIQUE** Keramik-Aufsatzwaschtisch „Melbourne“, weiß  
ceramic top-mounted washbasin „Melbourne“, white  
vasque à poser céramique „Melbourne“, blanc  
keramische opzetwastafel „Melbourne“, wit



**PUREFACTION** Mineralguss-Waschtisch, weiß  
cast mineral washbasin, white  
plan vasque en matériau de synthèse, blanc  
minerale wastafel, wit



**QUADA** Mineralguss-Waschtisch, weiß  
cast mineral washbasin, white  
plan vasque en matériau de synthèse, blanc  
minerale wastafel, wit



**QUADA** Keramik-Waschtisch, weiß  
ceramic washbasin, white  
plan vasque céramique, blanc  
keramische wastafel, wit



**ACE** Mineralguss-Waschtisch, weiß  
cast mineral washbasin, white  
plan vasque en matériau de synthèse, blanc  
minerale wastafel, wit



**ACE** Keramik-Waschtisch, weiß  
ceramic washbasin, white  
plan vasque céramique, blanc  
keramische wastafel, wit



**ACE** Glas-Waschtisch, optiwhite  
glass washbasin, optiwhite  
plan vasque en verre, optiwhite  
glazen wastafel, optiwhite



**VUELTA** Mineralguss-Waschtisch, weiß  
cast mineral washbasin, white  
plan vasque en matériau de synthèse, blanc  
minerale wastafel, wit



**LINEA** Mineralguss-Waschtisch, weiß  
cast mineral washbasin, white  
plan vasque en matériau de synthèse, blanc  
minerale wastafel, wit



**FRESH** Mineralguss-Waschtisch, weiß  
cast mineral washbasin, white  
plan vasque en matériau de synthèse, blanc  
minerale wastafel, wit



**FRESH** Keramik-Waschtisch, weiß  
ceramic washbasin, white  
plan vasque céramique, blanc  
keramische wastafel, wit



**FRESH** Glas-Waschtisch, optiwhite  
glass washbasin, optiwhite  
plan vasque en verre, optiwhite  
glazen wastafel, optiwhite





# NEXT GENERATION



puris Bad GmbH & Co. KG  
 Hinterm Gallberg 6a · D-59929 Brilon · mail@puris.de · www.puris.de

Abbildungen und Angaben sind unverbindlich. Technische Änderungen vorbehalten.  
 Illustrations and specifications are without obligation. Technical modifications reserved.  
 Reproductions et données techniques sans engagement de notre part. Sous réserve de modifications techniques.  
 Afbeeldingen en specificaties kunnen afwijken. Technische wijzigingen voorbehouden.

Fotos (2) TS: © jokatoons - fotolia.com · ammentorp - 123rf.com

